TOASTER OVEN

OPERATING INSTRUCTIONS

ET-VHQ21

- Always follow basic safety precautions when using electrical appliances.
- Read all instructions carefully.
Please keep this Operating Instructions at hand for easy reference.

INDEX

BEFORE USE

IMPORTANT SAFEGUARDS	2
IMPORTANT	4
BEFORE USE	5
PARTS NAMES	6
REPLACEMENT PARTS	6

HOW TO USE

HOW TO USE	7
TIME GUIDELINES	8

CLEANING AND MAINTENANCE

CLEANING AND MAINTENANCE	9
HOW TO ATTACH AND REMOVE PARTS	10

BEFORE CALLING FOR SERVICE

TROUBLESHOOTING GUIDE	11
SPECIFICATIONS	11

IMPORTANT SAFEGUARDS Be sure to follow these instructions.

These WARNINGS and CAUTIONS are intended to prevent property damage or personal injury to you and others.

■ The degree of danger or damage by the misuse of this product is indicated as follows:

 WARNING Indicates risk of serious injury or death.	 CAUTION Indicates risk of injury, household or property damage if mishandled.
--	--

■ Prohibited or required actions are indicated as follows:

 Indicates a prohibited operation.	 Indicates a requirement or instruction that must be followed.
--	---

WARNING

 **Do not modify the product. Only a repair technician may disassemble or repair this product.**
Attempting to do so may cause fire, electric shock or injury. Make any repair inquiries to the store you purchased the product.

 **Do not immerse in water or splash with water.**
Doing so may cause short circuit or electric shock.

 **Do not plug or unplug the Power Plug if your hands are wet.**
Doing so may cause electric shock or injury.

 **Do not use a power source other than 220-230 V AC.**
Using any other power supply voltage may cause fire or electric shock.

Do not use the product if the Power Cord or Power Plug is damaged or if the Power Plug is loosely inserted into the electrical outlet.

Doing so may cause electric shock, short circuit or fire.

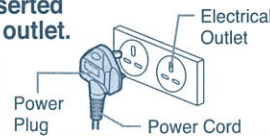

Do not damage the Power Cord.

Do not bend, pull, twist, fold, or attempt to modify the Power Cord. Do not place it on or near high temperature surfaces or appliances, under heavy items or between objects. A damaged Power Cord can cause fire or electric shock.

Do not use the product near flammable items or items vulnerable to heat, such as curtains.

Doing so may cause fire.

Do not use the Baking Tray containing oil.

Doing so may cause fire.

Do not allow children to use the product unsupervised. Keep it out of the reach of infants.

Children and infants are at risk of burns, electric shock or injury.

 **If the blades or surface of the Power Plug become soiled, wipe them clean.**
Doing so may cause fire.

Use only an electrical outlet rated at 10 amperes minimum, and do not plug other devices into the same outlet.

Plugging other devices into the same outlet may cause the electrical outlet to overheat, resulting in fire.

Insert the Power Plug completely and securely into the electrical outlet.

A loosely inserted Power Plug may cause electric shock, short circuit, smoke or fire.

Stop using immediately if you notice any of the following symptoms indicating malfunction or breakdown.

Continued use of the product may cause smoke, fire, electric shock or injury.

<Examples of malfunctions or breakdowns>

- The Power Plug or Power Cord has become very hot.
- The Power Cord is deeply damaged or deformed.
- The electricity turns on and off when the Power Cord is touched or moved.
- A Heater is broken.
- There is a burning smell.
- A part is cracked, rattling or loose.
- You feel a tingle or slight electrical shock.
- The product does not operate even though the Timer Knob is turned to a setting other than OFF.
- The timer cannot be turned off and the product remains on, etc.

If any of the above occurs, unplug the product immediately and return to the store where you purchased it for check-ups and/or repairs.

This product is not intended for use by persons (including children) with reduced physical, sensory or mental capabilities, or lack of experience and knowledge, unless they have been given supervision or instruction concerning use of the product by a person responsible for their safety. Children should be supervised to ensure that they do not play with the product.

CAUTION

Be sure to observe the following to prevent fire.



■ **Never leave the product unattended during operation.**

Foods may catch on fire.

■ **Do not overheat foods.**

Doing so may cause fire.

■ **Do not use the product for purposes other than cooking.**

Doing so may cause fire.

■ **Do not cook bread topped with butter or jam.**

Foods high in sugar, fat or oil burn easily and may cause fire.

■ **Do not use the product with objects on top or underneath it.**

The product or object may deform, melt or cause fire.



■ **Be sure to attach the Crumb Tray.** Not doing so may cause fire.

■ **Always use the Baking Tray for food that may fall through the Grilling Rack.** Not doing so may cause fire.

■ **Do not cook oily items like meat, fish, or fried foods directly on the Grilling Rack.**

- When cooking meat or fish, wrap in aluminum foil and place on the Baking Tray.
- Oil may leak even when using aluminum foil, so be sure to cook the foods on the Baking Tray.
- Otherwise oil from the foods may drip or spatter and cause fire.

■ **Do not use the product with the Door open.**

Foods may catch on fire.

■ **Do not let foods touch the Heaters.**

Doing so may cause fire.

■ **Do not use with the Grilling Rack removed.**

Doing so may cause fire.

If foods cause smoke or catch fire...



■ **Turn the Timer Knob to OFF immediately and unplug the Power Plug.**

Not doing so may cause fire.

If foods catch fire, do not open the Door until the flame extinguishes. Opening the Door will introduce air, causing the flame to become bigger. Do not attempt to put out the fire by pouring water on it, as it may cause the Door Glass to break.



■ **Do not touch hot surfaces (all parts except the Timer Knob and Door Handle) during use or shortly after use.**

Touching hot surfaces may cause burns.



■ **Unplug the Power Plug from the electrical outlet when the product is not in use.**

Leaving the Power Plug in an electrical outlet may cause burns or injury or cause the insulation to become damaged, resulting in electric shock, short circuit or fire.



■ **Do not place or use the product on unstable surfaces or on surfaces that are vulnerable to heat.**

Doing so may cause injury or fire.

■ **Do not use the product where it may come into contact with water or near heat sources.**

Doing so may cause electric shock, short circuit or fire.

■ **Do not use the product near walls or furniture.**

Heat may damage, discolor or deform walls or furniture. (See pg. 5 "INSTALLATION GUIDELINE".)

■ **Do not directly heat canned or bottled foods.**

The can or bottle may burst or become red hot, causing burns or injury.

■ **Do not hold or carry the product while it is still hot.**

Touching hot surfaces may cause burns.

This appliance is not intended to be operated by means of an external timer or separate remote-control system.



■ **During cooking, move birds and small animals that may be sensitive to smoke or smells to other rooms, and open windows or turn on exhaust fans.**

■ **Always unplug the product by holding the Power Plug, not by pulling the Power Cord.**

Pulling the Power Cord to unplug the product may cause electric shock, short circuit or fire.

■ **Allow the product to cool down before cleaning.**

Touching hot surfaces may cause burns.

■ **Be sure to clean after every use.**

Food crumbs and oil left behind may cause smoke or catch fire when cooking.

■ **It is hazardous to use this product with a broken Power Cord. If this cord is broken, you must have it replaced by the manufacturer or an authorized retailer.**

IMPORTANT

This product is intended for household use and similar applications listed below:

- Staff (employee) kitchen areas in shops, offices and other working environments.
- *This product is not intended for use by many unspecified people for a long period of time.

This product must not be used in the following areas:

- Farmhouses.
- By clients in hotels, motels and other residential type environments.
- Bed and breakfast type environments.

IMPORTANT

Requests during cooking To prevent smoke and fire during cooking

- Cook the following foods while watching them for burning. These foods burn easily and may catch fire. Never leave the product unattended.

Thin foods	Thinly sliced sandwich bread, thinly sliced pain de mie such as loaves of 8 or 10 slices, thinly sliced baguette, tortillas, kakimochi (thinly cut fried rice cakes), etc.
Oily or sugary foods	Tempura, fried foods, butter rolls, cookies, etc.
Foods that burn easily	Meat, fish, rice cakes, etc.

- To prevent fires, do not use the following kitchen utensils:
Parchment paper, baking paper, paper molds for cake mix, containers and wraps made of resin or silicone, etc.
- When using aluminum foil, be careful that it does not touch the Heaters or extend from the Baking Tray. If aluminum foil blocks part of the Oven Interior or touches the Heaters, it may cause fire, breakdown or damage to the product.

In the case of smoke or fire, do not immediately open the Door. Return the Timer Knob to OFF, unplug the Power Plug, and wait for the Main Body to cool before opening the Door.

Requests when handling and using parts

- Do not splash water on the Door (the Door Glass). Do not apply strong force to the Door Handle. Doing so may break the Door Glass or cause breakdown or damage to the product.
- Be careful not to apply strong impact to or otherwise damage the Door (the Door Glass). The Door Glass may break and cause injury.
- Do not place objects on the opened Door. Doing so may cause breakdown or damage to the product, or the product may tip and food may slide out.
- Do not open and close the Door vigorously. The Grilling Rack may come loose.
- Do not use the Grilling Rack or Baking Tray on a gas stove or with other cooking equipment. Doing so may cause deformation or damage.
- Be sure to observe the following to prevent damage to the Baking Tray.
 - Do not use rigid utensils such as metal spatulas, knives, or nylon brushes.
 - Line the bottom of the Baking Tray with aluminum foil before placing heat-resistant container on top.
 - Do not turn on the product with no food placed inside.
- Do not turn on the product with the Crumb Tray and Grilling Rack removed. Doing so may cause fire, breakdown or damage to the product.
- Do not line the Crumb Tray with aluminum foil. Doing so may cause breakdown or damage to the product.
- Do not place the product over direct flame (such as a gas stove top), or on top of electric or induction heating (IH) cookers. Doing so may cause fire, breakdown or damage to the product.
- Do not steam foods. The steam may cause breakdown or damage to the product.

INSTALLATION GUIDELINE

- Be sure to keep the distance in the illustration between the product and flammable items such as wooden walls and furniture, to prevent fire. (Not doing so may cause fire.)
- Make sure that vinyl cloths and walls or furniture etc. made of resin or other heat-sensitive materials are even further away than specified in the illustration. (The heat may deform or discolor such objects.)
- Leave **at least 30 cm** space in front and either to the right or left side of the product. (Do not place the product near walls or place obstructions around the product.)

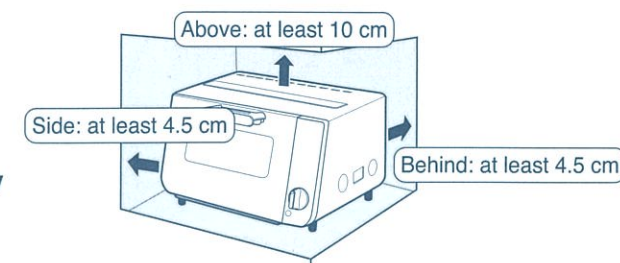

This symbol on the appliance indicates “Hot surface and should not be touched without caution”.

BEFORE USE

This product is used to toast sliced bread or heat fried foods. Do not use the product for other than the intended cooking purposes, or for commercial purposes.

- Be sure to remove all packaging materials inside the oven before use.
- Before using the product, make sure that the Timer Knob is set to OFF and insert the Power Plug into an electrical outlet.
- When the product is used for the first time, it may produce some smoke, but this does not indicate a malfunction.

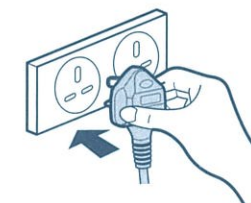

The Heaters may turn off during use. This does not indicate a malfunction.

HEATERS TURNING ON

- When the Oven Interior becomes hot, the Thermostat operates and the Heaters automatically turn on and off to prevent the product from overheating.
- When using consecutively, the Thermostat operates and the frequency of the Heaters turning on and off increases so the cooking time may need to be extended. Watch the food and adjust the cooking time accordingly.
- A click will be heard when the Heaters are turned on and off by the Thermostat. This sound does not indicate a malfunction.

PARTS NAMES

●The Grilling Rack and Crumb Tray can be removed. (See pg. 10)

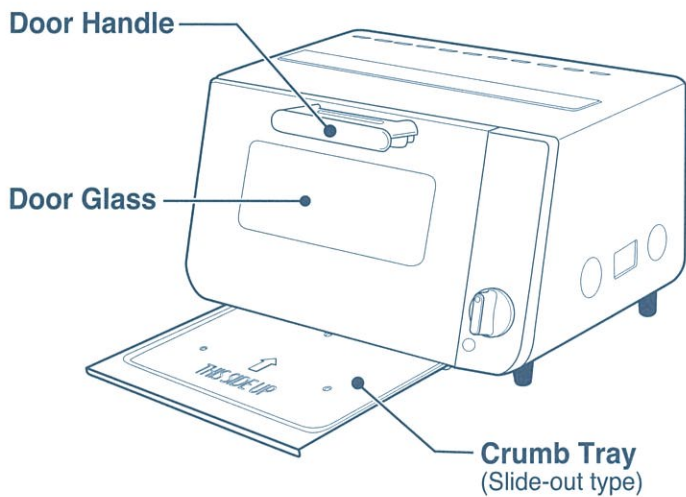
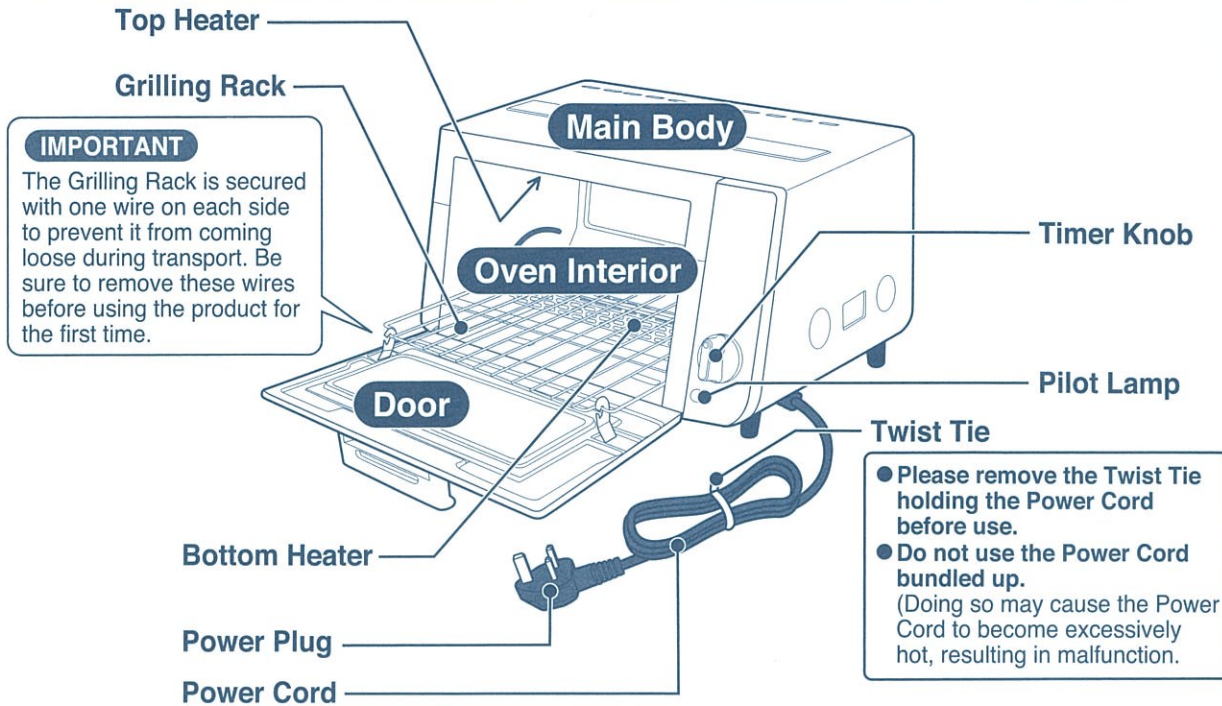

Accessory Baking Tray (1 pc)

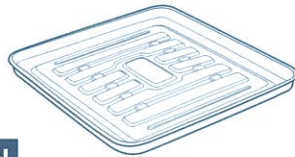

CAUTION

- The Baking Tray may make noises due to warping during cooking, but this does not indicate a malfunction.
- Line the bottom of the Baking Tray with aluminum foil to help prevent messes and/or stains. When heating pizza or fried foods, press the aluminum foil with your fingers to form it to the shape of the Baking Tray for better cooking results.
- The pattern from the Baking Tray may appear on the bottom of foods.

REPLACEMENT PARTS

- Replacement parts may be available for an additional charge. Please replace damaged parts only with new parts.
- When replacing parts, please record the model number and part name beforehand. Then contact the store where you purchased the product.

Part Name	Part Number
Baking Tray	BX188029G-00
Grilling Rack	BX188027G-00
Crumb Tray	BX188028G-00

HOW TO USE

1 Insert the Power Plug into an electrical outlet, arrange the foods evenly on the Grilling Rack, and close the Door.

- Use the Baking Tray for foods with liquid. The Baking Tray may warp depending on the type of food being heated. Arrange the foods evenly across the Baking Tray, or use an oven-safe dish.
- Do not place foods on the opened Door.
- Arrange foods evenly as shown below, as they may cook unevenly depending on how they are placed.
- Arranging foods as shown may not be possible depending on the size, type, or shape of the food.

When reheating...
When reheating pork cutlets, croquettes, or other fried foods, wrap them in aluminum foil to prevent oil from spattering.

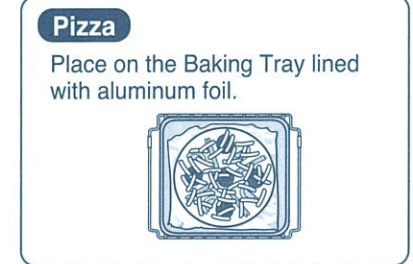
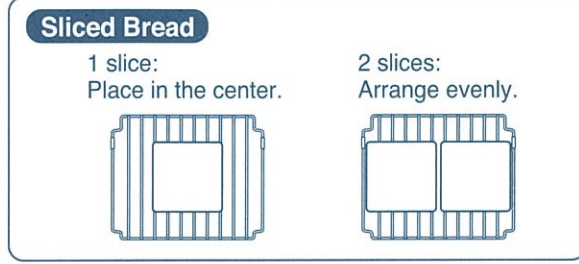

2 Set the timer.

When the Timer Knob is turned, the Pilot Lamp turns on and cooking begins. (See pg. 8 for "TIME GUIDELINES".)

- Preheating is not necessary.
- Return the Timer Knob to OFF before removing or inserting foods.
- Overheating foods may burn them or cause them to catch fire. Be especially careful when cooking thin foods, oily or sugary foods, and foods that burn easily (See pg. 4).

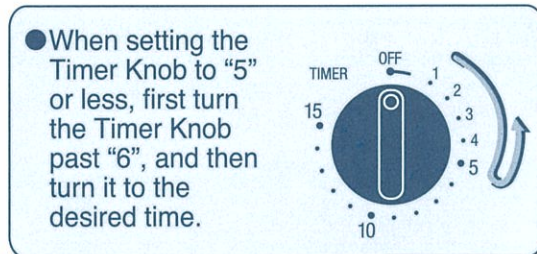

3 Cooking completes.

When the set time has passed, a "ding" sounds and cooking is finished. (The Pilot Lamp turns off.)

- The Baking Tray and other parts are hot. Please use an oven mitt or other cloth when removing foods.
- Unplug the Power Plug from the electrical outlet after use. (Always hold the Power Plug. Never pull on the Power Cord.)

TIME GUIDELINES

- The cooking times noted below are guidelines. Never leave the product unattended, and watch the foods while cooking. Be especially careful when cooking a small amount of food, as the food may burn easily or catch fire when cooked for the times noted below.
- The actual cooking time and how the food is cooked will vary according to the room temperature, the temperature inside the oven, the temperature, size, amount and type of foods, the container used, and other factors.
- When performing consecutive cooking, the thermostat may operate, preventing the Heaters from turning on for a while. Watch the foods and adjust the cooking time accordingly.
- The cooking time for toast is set so that the bottom side becomes a light brown color.

Food	Amount	Baking Tray	Aluminum Foil	Cooking Time (Approx. Minutes)	Notes
Toast	2 slices	—	—	3–4.5	A loaf of bread cut into 8 slices at room temperature ● Set the cooking timer shorter when toasting 1 slice.
Gratin	1 dish	(Required)	(Required)	14–15	1 dish weighing approx. 240 g ● For casseroles with ingredients that may spill out or boil over, place on the Baking Tray lined with aluminum foil on the bottom. ● Refrigerating food will result in prolonged cooking time.
Pizza	1 pizza	Required	Required	4.5–5	Diameter of approx. 15 cm (6") ● Place on the Baking Tray lined with aluminum foil and bake. ● Cover with aluminum foil once it reaches your desired color.
Frozen Pizza				8–9	
Reheating of Fried food	4 pieces	Required	Required	10–10.5	1 piece weighing approx. 60 g ● Wrap each piece in aluminum foil.
Reheating Pre-cooked Frozen Food	6 pieces	Required	Required	7.5–8	1 piece weighing approx. 25 g
Heating up the Butter Rolls	3 pieces	—	—	2.5–3	1 piece weighing approx. 35 g
Hot dog	2 pieces	—	Required	10–11	Insert cooked ingredients into each bun, and then wrap each hot dog in aluminum foil.

- Be careful when toasting thinly sliced sandwich bread, thinly sliced pain de mie such as loaves of 8 or 10 slices, or thinly sliced baguette, as these foods burn easily and may catch fire.
- Be careful not to overheat fried foods as oil seeping out from the food may ignite.
- Toasting breads or foods with moisture may cause steam to arise from the gap between the Main Body and Door. This does not indicate a malfunction.

COOKING TIPS

KEY POINTS
1

Use aluminum foil.

- Wrap foods that may spatter oil in aluminum foil.
- Cover foods that burn easily or thick foods with aluminum foil once they are browned.



KEY POINTS
2

Use the Baking Tray.

- Use the Baking Tray for small foods that may fall through the Grilling Rack, foods that lose their shape or melt (freshly pounded rice cakes, cheese, etc.) or foods with ingredients that may spill out.

KEY POINTS
3

When heating frozen foods...

- Always use commercially frozen foods that are for toaster ovens, and refer to the "TIME GUIDELINES".
- Be careful when cooking commercially frozen croquettes, as the contents may pop out if overheated.
- Removing frost from the surface of foods reduces uneven cooking.
- If foods do not warm up, leave them inside the oven for a period after the cooking time ends to warm using residual heat.

KEY POINTS
4

When toasting frozen breads...

- Once the surface is browned, turn the Timer Knob to OFF and leave the bread inside the oven for an additional 2 to 3 minutes (because the inside of the bread does not heat easily even though the surface is toasted).

KEY POINTS
5

When heating tempura...

- Depending on its size, tempura may burn easily, so watch the food and adjust the cooking time accordingly.
- Be sure to wrap the food in aluminum foil.

CLEANING AND MAINTENANCE

Be sure to unplug the Power Plug from the electrical outlet and allow the product to cool before cleaning.

IMPORTANT

- Do not use the following:
 - Detergents other than mild kitchen detergent, paint thinner, or bleach. (Doing so may cause discoloration, cracks, degradation or corrosion.)
 - Polishing powder, nylon brushes, scrub brushes, anything made with metal, eraser pads, hard nylon sponges and abrasive cleaners. (Doing so may damage the surface.)
- When using chemically treated cloths, do not rub too hard or leave them on the product for a long time as the surface of the product may become damaged, or chemical reactions may occur.
- Do not use a dishwasher or dish-dryer.

Main Body (exterior and Oven Interior) / Door

- ① Moisten a soft cloth with diluted mild kitchen detergent, firmly wring out the cloth, and wipe away any dust.
- ② Wipe with a soft cloth moistened with water and well-wrung.
- ③ Wipe away any moisture with a dry soft cloth.

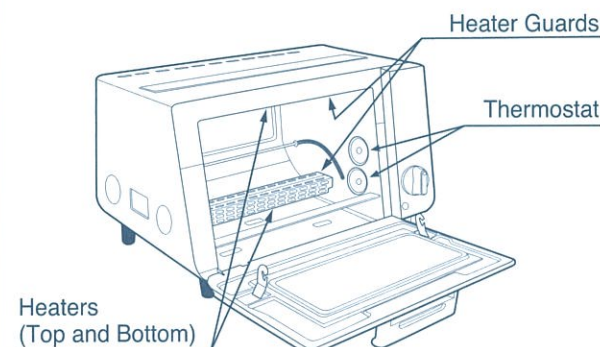

NOTE

- Do not splash water directly onto the Main Body or Door, or immerse the product in water. (Doing so may cause electric shock or breakdown to the product.)
- Do not touch the Heaters. (The Heaters may break.)
- Be careful not to apply strong impact to or otherwise damage the Door (the glass). (The glass may break.)
- Do not press against or pull the Heater Guards.
- Do not touch the surface of the Thermostat. (Heavily scratching or otherwise damaging the surface of the Thermostat may cause fire or breakdown to the product.)
- Clean the Oven Interior after every use. (Using the product in an unclean condition may result in uneven cooking or prolonged cooking time.)

Baking Tray / Crumb Tray / Grilling Rack

Baking Tray / Crumb Tray

- ① Wash with diluted mild kitchen detergent.
- ② Rinse with water.
- ③ Wipe away any moisture with a dry soft cloth.

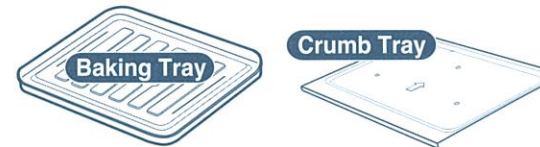

Grilling Rack

- ① Wash by immersing it in warm water with mild kitchen detergent diluted.
- ② Rinse with water.
- ③ Wipe away any moisture with a dry soft cloth.



NOTE

- Clean after every use. If the Crumb Tray is not cleaned, food crumbs may adhere and become difficult to remove. (Using this product with dirt stuck to the Crumb Tray may cause fire or burn the tabletop or countertop. It may also result in uneven cooking, such as the bottom side of the bread not toasting well.)
- Remember to securely attach the Crumb Tray and Grilling Rack after cleaning.
- After washing, wipe away any moisture and allow them to dry completely before attaching the parts. (Not doing so may cause rust.)
- Do not soak the removable parts or leave it immersed in water for a long time. (Doing so may cause rust.)

Power Cord / Power Plug

Wipe clean with a dry soft cloth.

HOW TO ATTACH AND REMOVE PARTS

Be sure to unplug the Power Plug from the electrical outlet and allow the product to cool before attaching or removing parts.

Grilling Rack

HOW TO REMOVE

① Open the Door halfway, pull out the Grilling Rack in the direction of the arrow, and disengage it from the Door Hooks (one on each side).

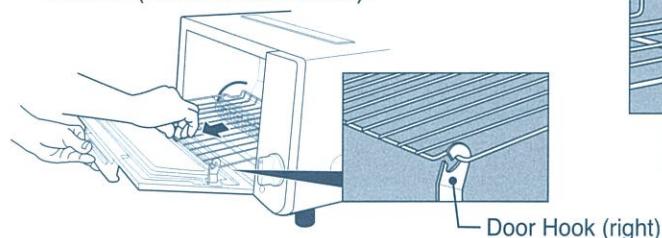

② Move the Grilling Rack gently toward the back of the Oven Interior and disengage it from the Rack Support.

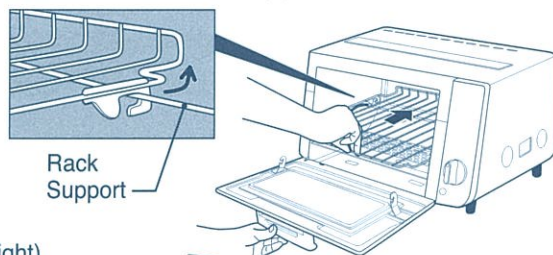

IMPORTANT

Once the Grilling Rack is removed, the Door is no longer supported by the Grilling Rack. Since the Door will open in front, please open and close the Door carefully and do not apply strong force to the Door. (Doing so may cause deformation, breakdown or damage to the product.)

HOW TO ATTACH

① Move the Grilling Rack gently toward the back of the Oven Interior and engage the Grilling Rack Hooks (one on each side) on the Rack Support.

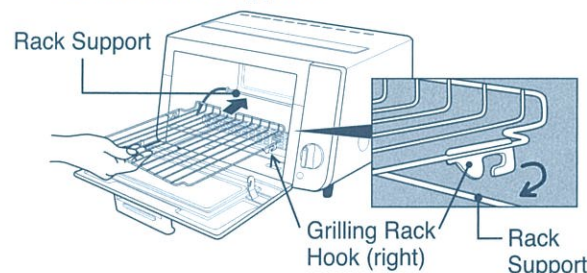

② Slightly lift the Door up, pull out the Grilling Rack in the direction of the arrow, and engage the Rack corners (one on each side) on the Door Hooks (one on each side).

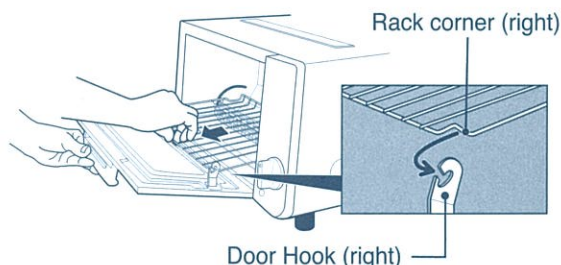

IMPORTANT

Be sure to attach the Grilling Rack to the Rack Support and the Door Hooks.

Crumb Tray

Pull out toward the front.

The "THIS SIDE UP" mark indicates which side should face up.

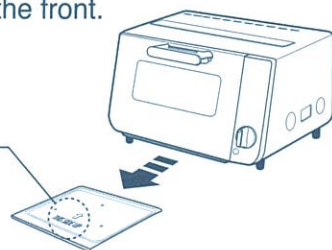

IMPORTANT

● The Crumb Tray has top and bottom sides. Insert the Crumb Tray so the "THIS SIDE UP" mark is facing up.

TROUBLESHOOTING GUIDE

Please check the following points before calling for service.

Problems	Cause	Remedy
Food does not cook. (The Heaters do not turn on.)	Is the Power Plug inserted securely into an electrical outlet?	Insert the Power Plug firmly into the electrical outlet.
	Was the Timer Knob set?	Set the Timer Knob.
The Heaters turn off partway through cooking.	This does not indicate a malfunction. This product has a thermostat that automatically turns the Heaters on and off while cooking. When using consecutively, the thermostat operates and the frequency of the Heaters turning on and off increases, so the cooking time may need to be extended.	
The bottom side of bread does not toast well.	This product is pre-set so that the bottom side of bread is toasted slightly lighter than the top side. Thick-sliced bread will be closer to the Heater, and the top side may toast slightly darker.	
	If the Crumb Tray is not cleaned, the bottom side of the bread may not toast as well as it did at the time of purchase.	Clean the Crumb Tray. (See pg. 9) Clean the Crumb Tray after every use. If not cleaned, food crumbs may stick and become difficult to remove.
Bread toasts unevenly.	Is the bread arranged evenly on the Grilling Rack?	Arrange the bread evenly. (See pg. 7)
	The toasted color will vary depending on the size, bread type, thickness, number of slices, and other factors.	

SPECIFICATIONS

Model No.	ET-VHQ21
Rating	AC 220-230 V 50/60 Hz
Electric Consumption	777-850 W
Timer	Up to 15 minutes
Length of the Power Cord	1.0 m
External Dimensions (approx. cm)	39 (W) × 29 (D) × 23 (H)
Interior Dimensions (approx. cm)	26 (W) × 21 (D) × 10 (H)
Weight	Approx. 3.6 kg

● This product is not suitable for use in countries or regions with different power supply voltages or frequencies.

WARNING - THIS APPLIANCE MUST BE EARTHED

IMPORTANT

The wires in this mains lead are coloured in accordance with the following code:

Green-and-yellow:Earth Brown:Live Blue:Neutral

If the colours of the wires in the mains lead of this appliance do not correspond with the coloured markings identifying the terminals in your plug, proceed as follows.

The wire which is coloured green-and-yellow must be connected to the terminal in the plug which is marked with the letter E or by the earth symbol or coloured green or green-and-yellow. The wire which is coloured blue must be connected to the terminal which is marked with the letter N or coloured BLACK.

The wire which is coloured brown must be connected to the terminal which is marked with the letter L or coloured RED.

This appliance must be protected by a 13A fuse if a 13A (BS1363) plug is used or, if any other type of plug is used, by a 10A fuse either in the plug or adaptor or at the distribution board.

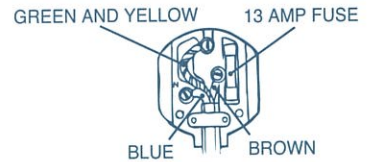

How to change the Fuse

If the Power Plug of your Power Cord (see pg. 6) is,

A. A type that can be disassembled. Refer to above.

B. A solid molded type that can not be disassembled. Please refer to the following.

1. Open the Fuse Cover of the Power Plug.
2. Remove the Fuse installed inside.
3. Install a new Fuse on the Fuse Cover and fit back it to the Power Plug.

(Be sure to replace with a Fuse of the same current value as the installed Fuse.)

